

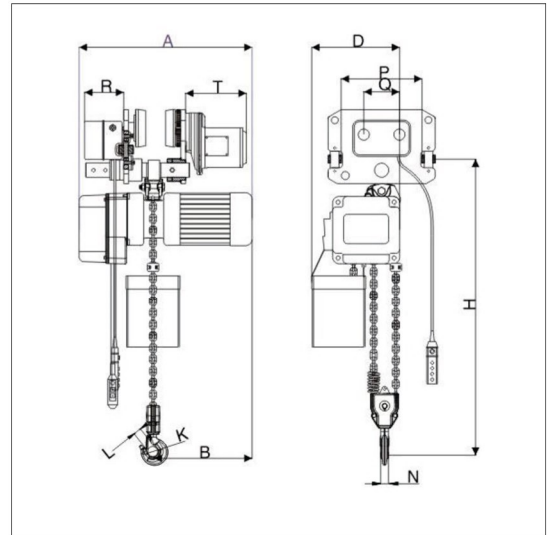

05 - 02



Hoist with the Electric trolley

● Technical parameters

Type	Capacity (Ton)	Lifting height (m)	LIFTING MOTOR			OPERATING MOTOR			I-Beam (mm)
			Power(kw)	Lifting speed (m/min)	Voltage	Power(kw)	Operating speed (m/min)	Voltage	
CH-5-2	5	4(6)	3.0	2.7	380V/50Hz	0.75	10(20)	380V/50Hz	110 - 180

● Size specification

Type	Capacity (Ton)	Unit(mm)											
		H	A	B	D	K	L	N	R	T	P	Q	Chain
CH-5-2	5	880	785	395	465	Ø60	45	43	142	231	296	156	Ø11.2